

Retreat Range

Workshop

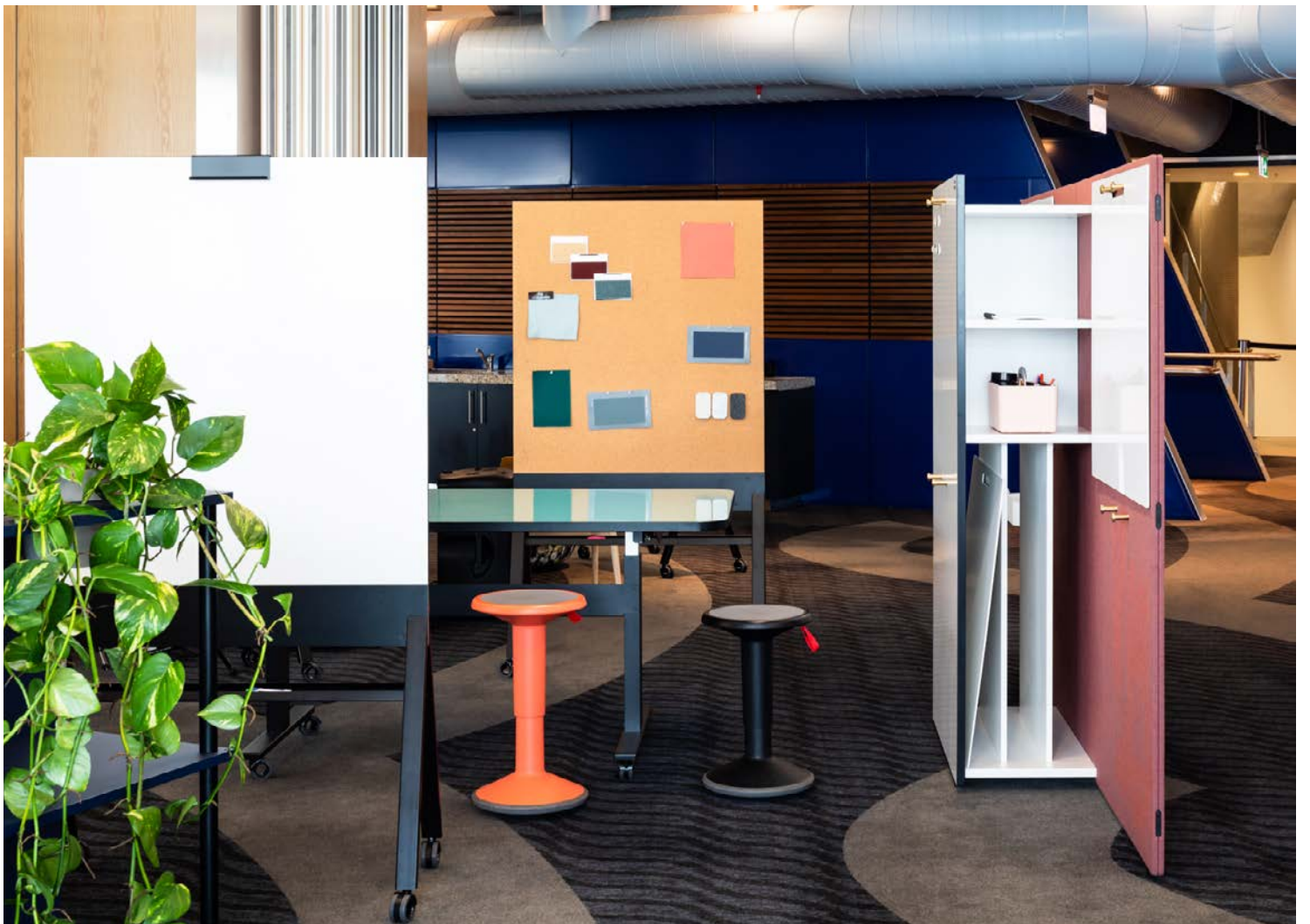

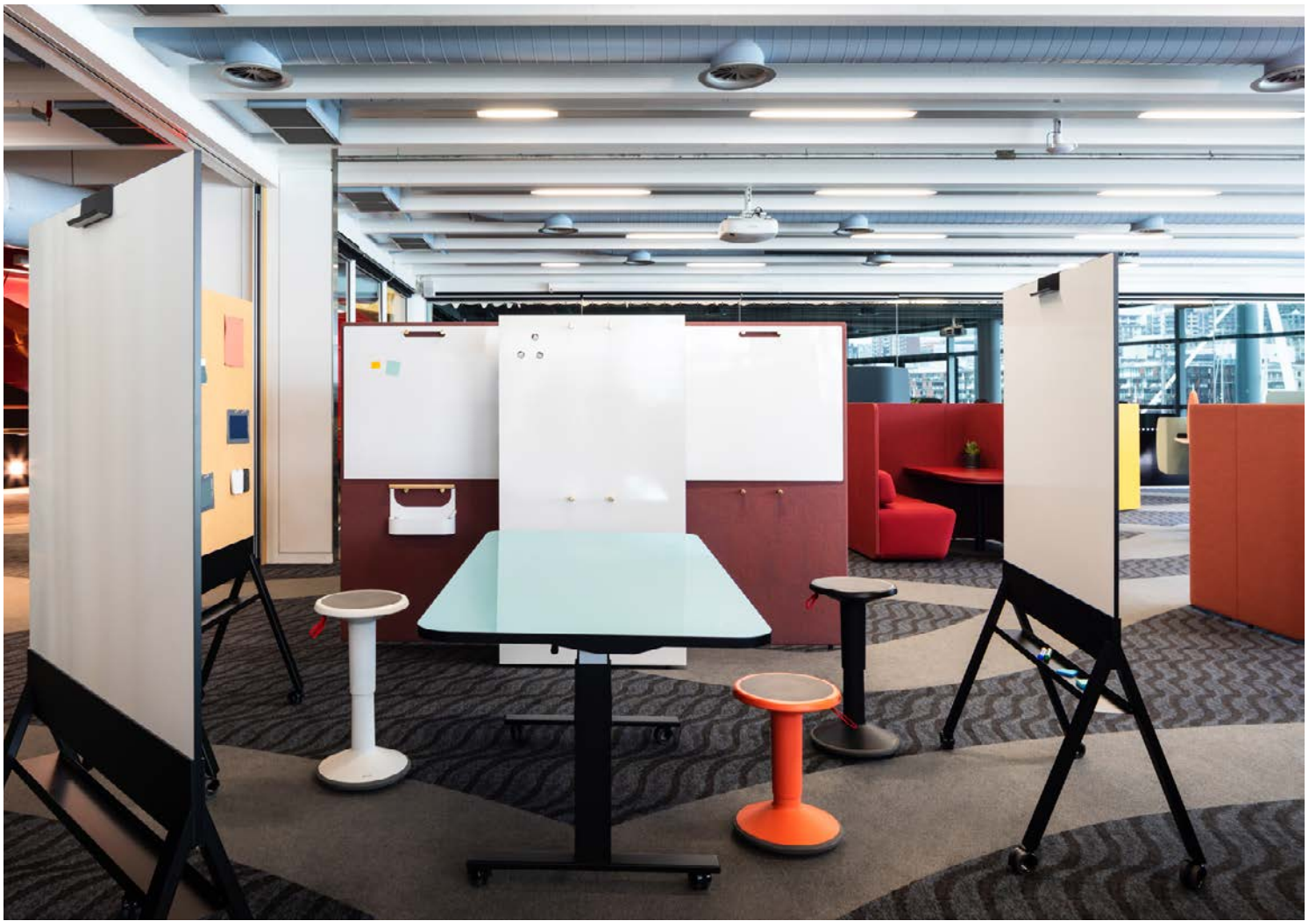

Retreat Range

Workshop

FEATURES

Retreat Workshop provides an ideal backdrop for your brainstorming meetings. The soft, upholstered screen creates a quiet “retreat” and removes distractions. Accessorise with tools and tactile surfaces to encourage creative thinking.

Dimensions

2800L x 450D x 1800H
Custom sizes available

Options

Upholstered in your choice of fabric
Variety of shelving options available
Storage or TV wall on rear side
Seismic anchor available

Accessories

Wall hooks, visual mobile boards (VMBs), magnetic whiteboards.

Fully upholstered screens with foam backing.

Adjustable levelling glides

100% designed and made in New Zealand

ISO14001

10 year warranty

6-8 week lead time



Retreat Workshop



Retreat Workshop - storage compartment - top shelves



Retreat Workshop - optional TV wall on rear side



Retreat Workshop - storage compartment - bottom shelves

Retreat Range

Workshop

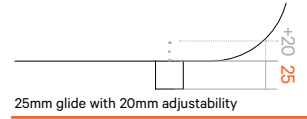

Glide detail

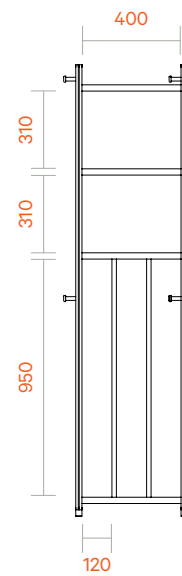
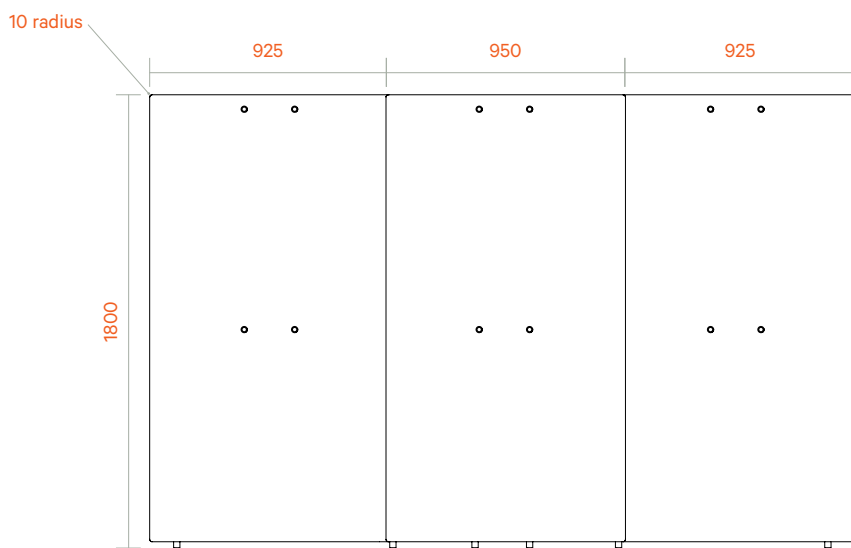
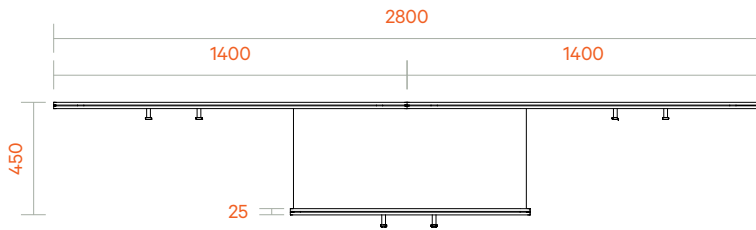
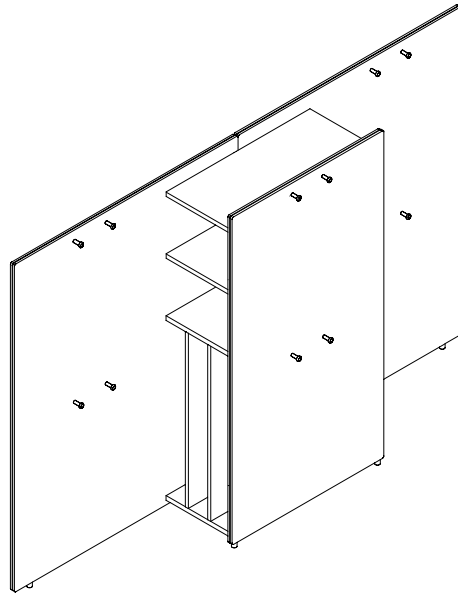

Retreat Workshop - RW-S-VMB001

Retreat Range

Workshop

Accessories

FEATURES

Solid Brass Retreat Wall Hook

Retreat tool box made of steel with a solid oak handle. Powder coated in various colours.

Moveable VMB whiteboard panel 900Wx850H



Retreat wall hooks (VA-WH)



Retreat toolbox (VA-TB)



Movable whiteboard panels (VA-VMBB)

Retreat Range

Workshop

Generic cable management



Cable snake where required otherwise fed from wall

- Data cables (by others)
- Softwire power cables

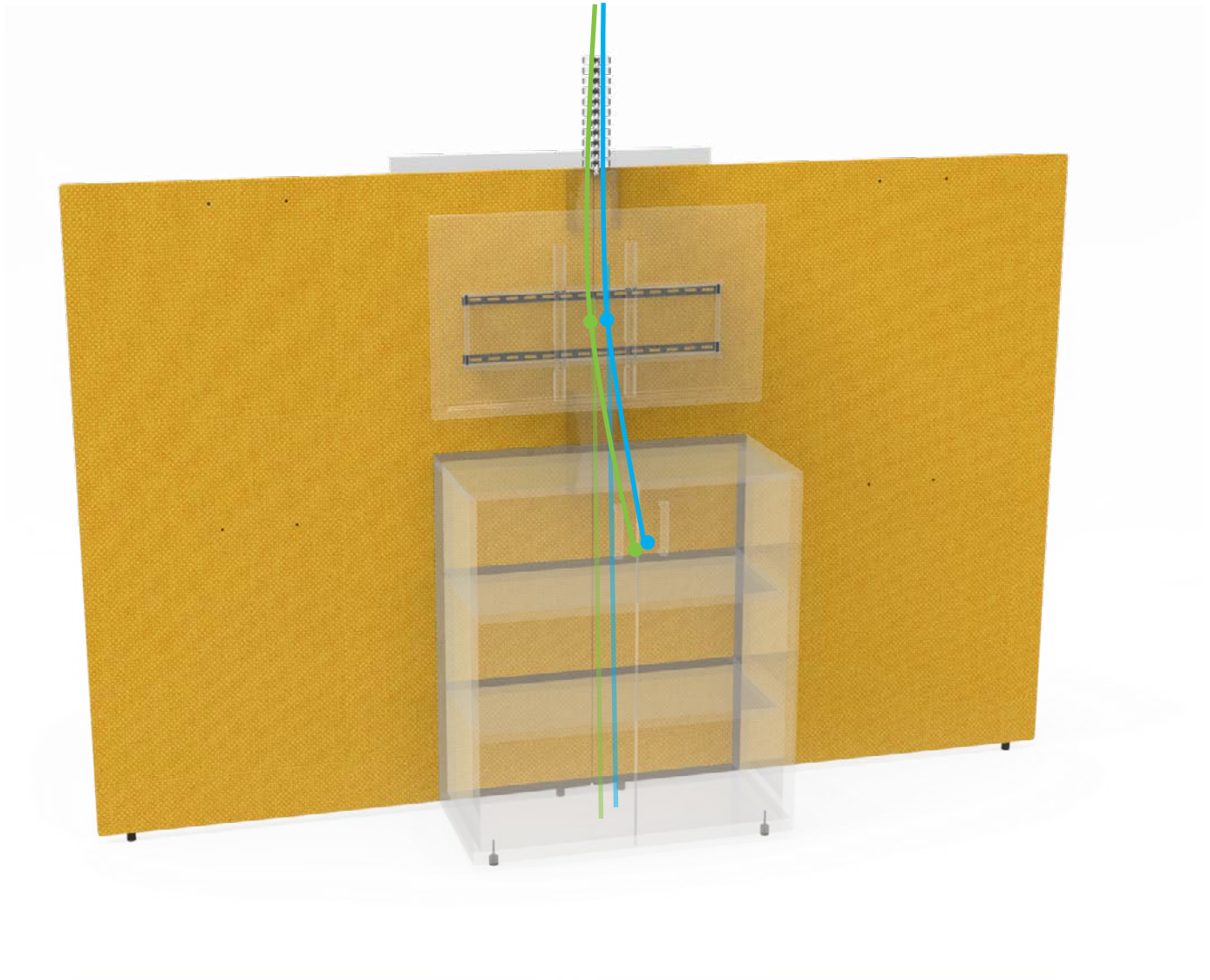

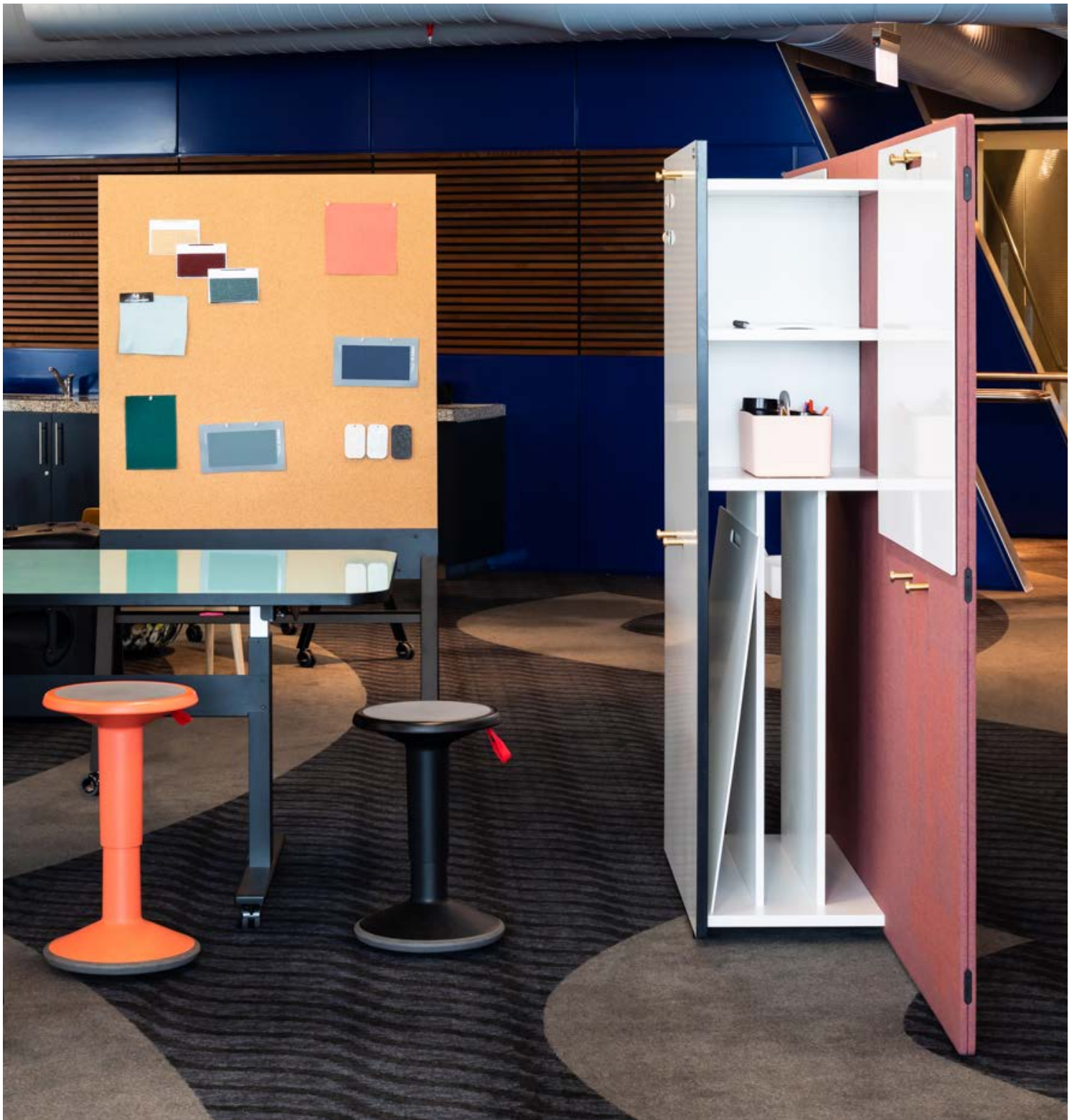

vidak.co.nz

Auckland

66 Lady Ruby Drive
East Tamaki, Auckland 2013
PO Box 58820 Botany
Auckland 2163
New Zealand

T +64 9 273 0033
F +64 9 273 0032

E sales@vidak.co.nz

Wellington

303 Willis Street
Te Aro, Wellington 6011
PO Box 9171
Wellington 6011
New Zealand

T +64 4 802 4615
F +64 4 802 4659

E sales@vidak.co.nz

